

Direct D400 Controller with SimpliCal[®] Auto Calibration

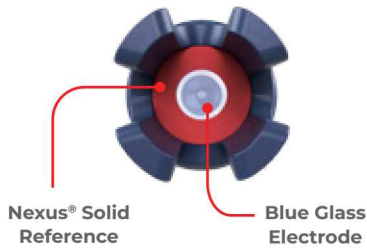

Direct 4-20mA



- ✓ 4-20mA Output
- ✓ Temperature Compensated
- ✓ Nexus[®] Solid KCl Reference
- ✓ No Preamp Required
- ✓ High Accuracy
- ✓ Quick Response Time
- ✓ 3/4" NPT Connection
- ✓ PP or PPS Body Materials
- ✓ RS 485 Modbus Communication

High performance industrial sensor for harsh applications

The ProCon[®] P14C Nexus[®] series offers the ultimate combination of durability, functionality and long-term performance; exactly what is required for industry's most complex applications. The Nexus[®] reference eliminates reference poisoning. The sensors are available in flat planar or bulb style design.

The double junction coupled with the solid Nexus[®] KCl infused reference makes the P14C pH sensor an excellent choice for complex process media applications.

All measurement functions are combined in one compact body — measuring electrode, temperature sensor and an inner reference chamber.

The 2-wire 4-20mA, 4-wire or 4-20mA + RS485 output options simplify calibration and communication with remote displays and controllers.

- ✓ Double junction reference extends sensor life and protects against poisoning ions
- ✓ Durable crack resistant low ionic glass enhances performance and increased reliability
- ✓ Operates in sub-zero temperatures down to 14°F (-10°C)
- ✓ Advanced electronic diagnostics provides excellent repeatability and reliability

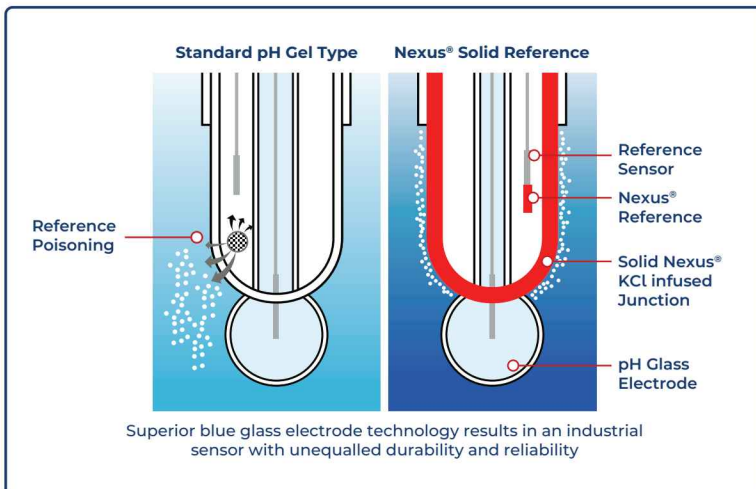

Smart Sensor Technology

Advanced electronic circuitry stores pH data for automatic sensor recognition and trouble-free calibration when connected to the ProCon[®] Controller.

Outputs

1. 4-20mA 2-Wire
2. 4-20mA + RS485

Both the measuring and reference electrodes are encapsulated within the non-porous advanced KCl infused polymer known as Nexus[®].

Less Calibration and Maintenance

Most sensors require on-going recalibration and are prone to premature failure due to what is known as gradient drift, or sensor drift.

The Nexus[®] series is a solid reference material. Poisoning or leaching of the reference electrolyte that occurs in standard sensor is greatly reduced.

The Nexus reference helps to eliminate the need for ongoing maintenance or cleaning requirement due to fouling or film build up removal which occurs with many process applications with traditional pH sensors.

Faster Response-Longer Lasting

The solid Nexus[®] reference provides for faster response time to changing pH values since there is no requirement for a junction.

- ✓ No Costly Preamps Required
- ✓ Direct 4-20mA & RS485 Outputs



Advanced electronic circuitry stores pH data for automatic sensor recognition and trouble-free calibration when connected to the ProCon[®] Controller

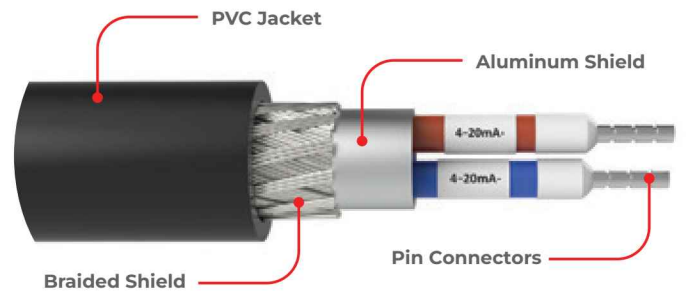

Enhanced chip technology allows for remote calibration as well as diagnostic data

Data analysis and direct 4-20mA signal or RS485 Digital outputs

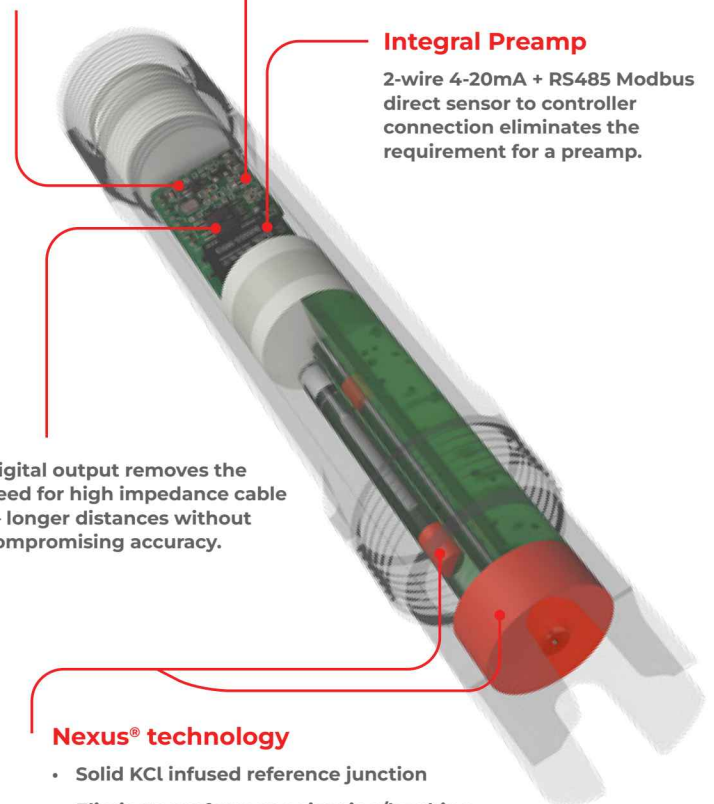

Nexus[®] technology

- Solid KCl infused reference junction
- Eliminates reference poisoning/leaching
- Extended life expectancy



Specifications

Measurement Range	
pH	0 – 14
Output Signal — No Preamp Required	
2 Wire Loop Powered 4-20mA + RS 485 Direct Sensor Output	
Accuracy	
7.00 ± 0.25	
Operating Temperature	
14 to 176°F -10 to 80°C Automatic Temperature Compensation	
Maximum Pressure	
150 Psi at 140°F (60°C) — See Pressure vs. Temp Graph	
Design	
Sensor body	PP Polypropylene (std) Ryton [®] PPS
Reference System	3.3 Mol Ag / AgCl / KCl Double Junction
pH electrode	Blue Glass Bulb Flat
Reference	Solid Nexus [®]
Connection	3/4" NPT
Measuring Electrode Resistance	< 500 MΩ
Impedance Range	102 – 675 MΩ
Temperature Compensation/Output- 4-20 + RS485 Model	
Pt-1000 (Std)	
Pt-100	

Temperature Control

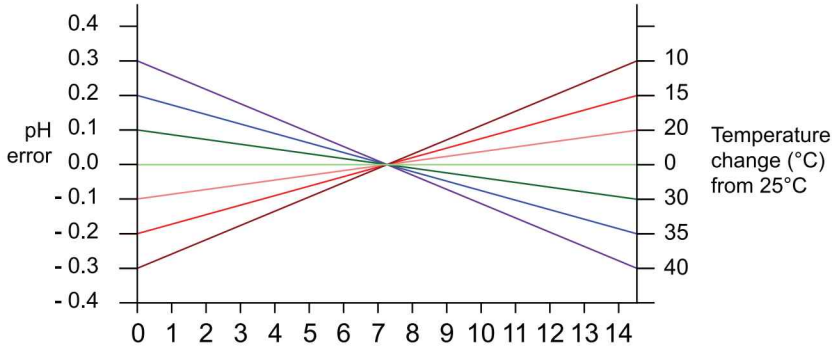

Temperature vs. Pressure

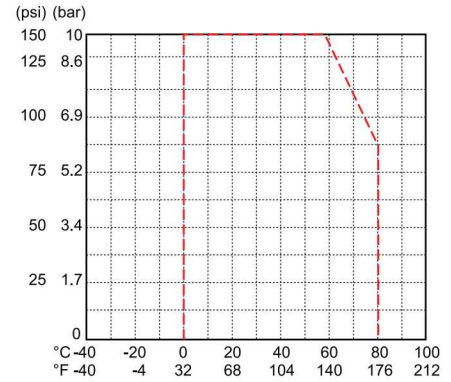

In-line Mounting

1. If air is present, avoid vertical installation (okay if pipe is full).
2. Optimum installation 15° above horizontal.
3. Process liquid should flow upward. (for downward flow ensure backpressure is present in order to avoid air within pipe)

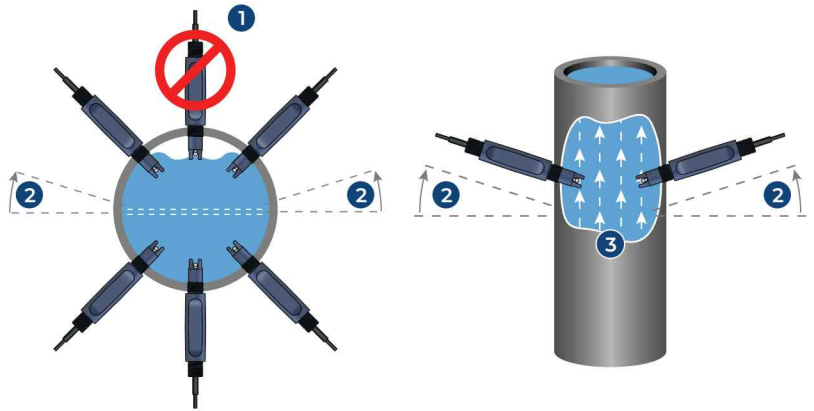

Typical Application

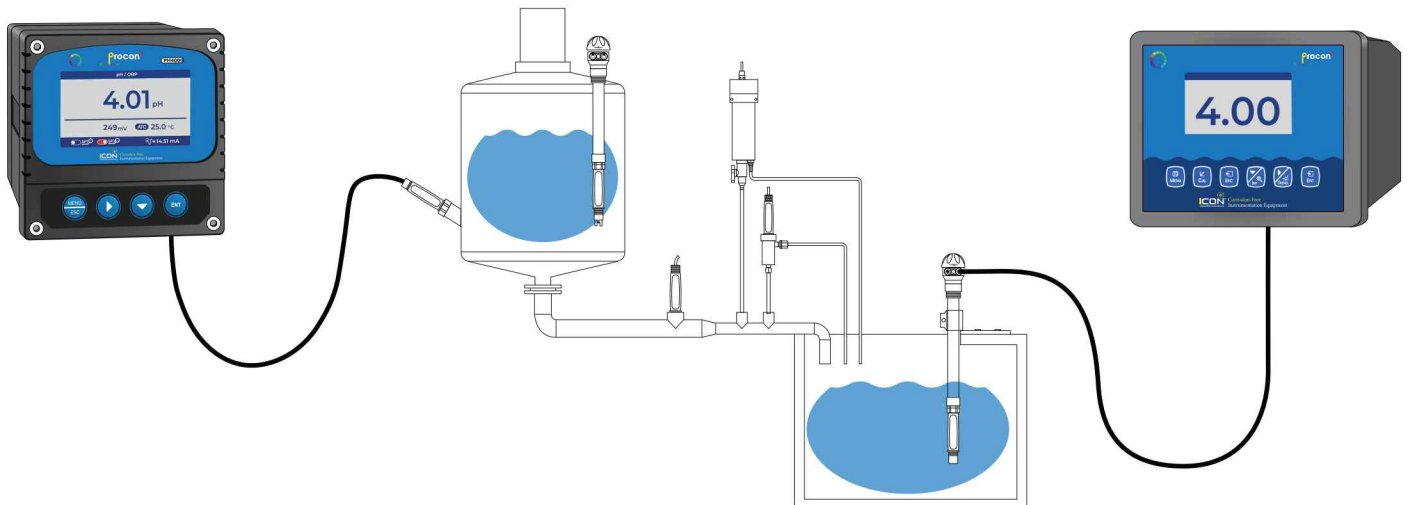

Cable Options

The ProCon[®] series offer complete flexibility of cabling options throughout the range. All cables are shielded against spurious EMF and are potted inside the sensor ensuring environmental protection.

The standard cable length for most sensors is 5m (15 ft). However, cables can be supplied as any continuous size up to 20m (66 ft).

Standard accessories include junction boxes and submersion couplers, typically used with extension cables for direct connection to the ProCon[®] Controllers.

Extension cables also permit distances between sensor and instrument of up to 30 m (100 ft.) without external preamplifier.



Pin leads

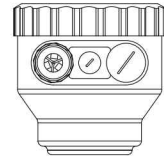

J-Box

Temperature compensation

The temperature compensator enables sensor to adjust for temperature effects on the glass pH electrode output.

The sensor can also use this measurement to compensate for solution pH temperature effects.

Sensors can be ordered with integral temperature sensors. The integral temperature compensator is available in two outputs — Pt 1000 (std) and Pt 100.

Temperature compensator

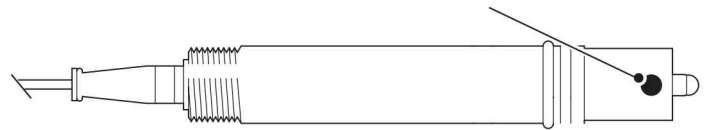

Typical Installations

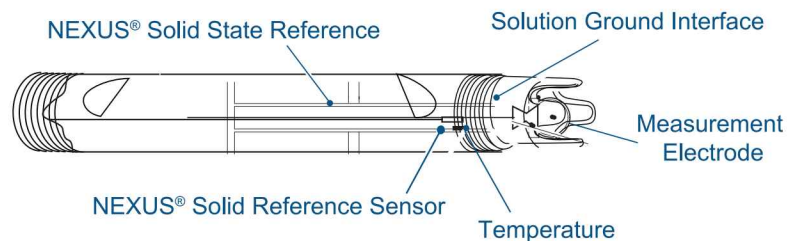
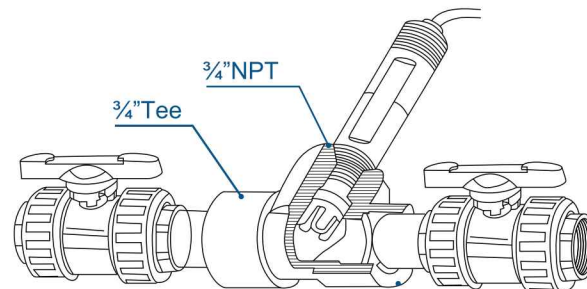
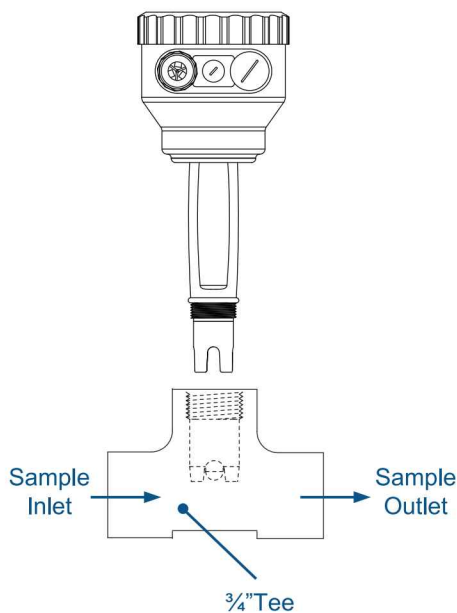

Wiring

4-20mA 2-wire

- ① Blue: mA-
- ② Brown: mA+



4-20mA 4-wire

- ① Transparent: 4-20mA
- ② Black (thick): Ref
- ③ Red: Temperature
- ④ Black: Temperature

Connects directly to ProCon® controller



4-20mA + RS485 Output

- ① Red: 9-24VDC +
- ② Black: 9-24VDC -
- ③ Transparent: 4-20mA
- ④ Black (thick): Ref
- ⑤ Green: RS 485 A
- ⑥ White : RS 485 B



Dimension

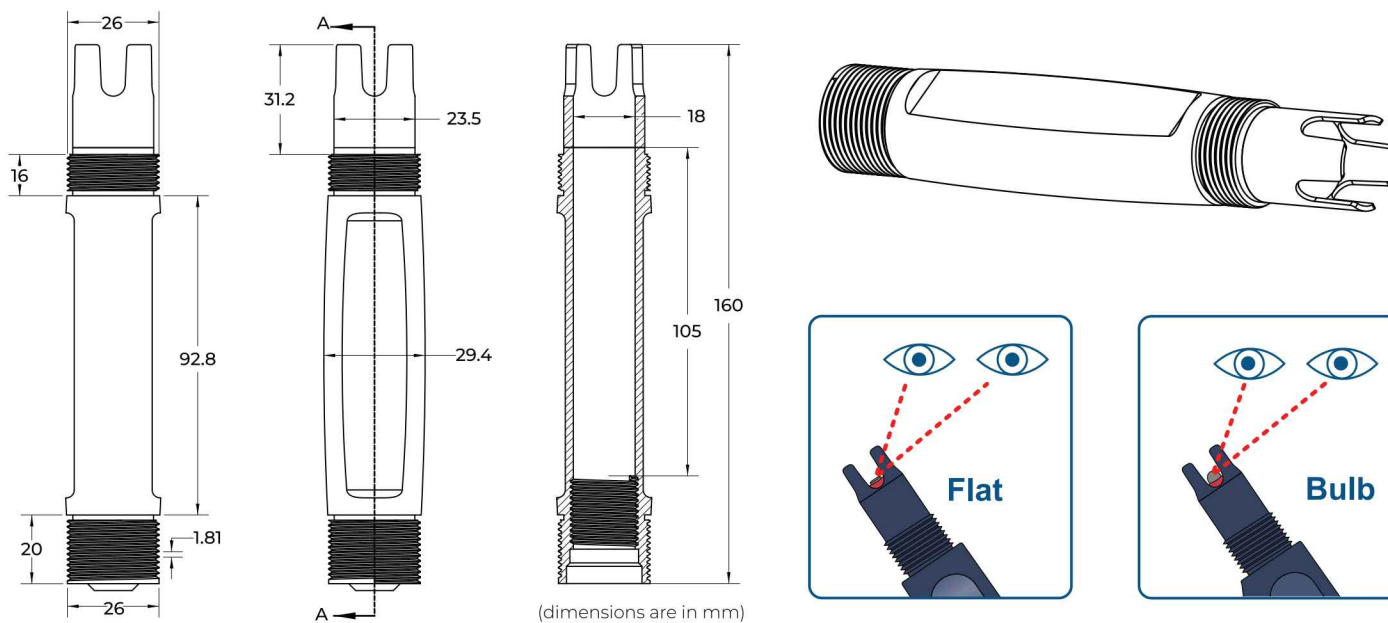

Model Selection

P14C - P - M - 1 - F - J

Material	Output	Electrode	Sensor Type	Connection
P: PP (std) R: Ryton®	M: 4-20mA (2-wire, standard) D: 4-wire (for ProCon® display) S: RS485 + 4-20mA	1: PT1000 (std) 2: PT100	F: Flat (std) B: Bulb	J: J-Box F: Flying Lead